

≡COFLOW

EcoFlow DELTA 2 Smart Extra Battery User Manual V1.0

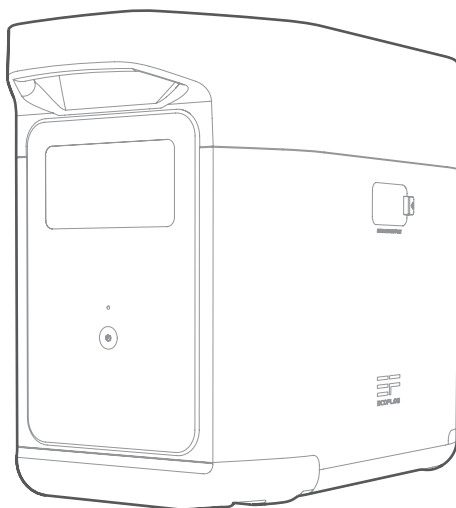

Disclaimer

Read this user manual carefully before using the product to ensure that you completely understand the product and can correctly use it. After reading this user manual, keep it properly for future reference. Improper use of this product may cause serious injury to yourself or others, or cause product damage and property loss. Once you use this product, it is deemed that you understand, approve and accept all the terms and content in this document. EcoFlow is not liable for any loss caused by the user's failure to use this product in compliance with this user manual.

In compliance with laws and regulations, EcoFlow reserves the right to final interpretation of this document and all documents related to this product. This document is subject to changes (updates, revisions, or termination) without prior notice. Please visit EcoFlow's official website to obtain the latest product information.

Contents



Specifications	1
Safety Instructions	2
What's in the Box	3
Product Details	3
Overview	3
LCD screen	4
Power On/Off	4
Usage	5
With DELTA 2	5
With Smart Generator	6
Storage and Maintenance	6
FAQ	7
Troubleshooting	7
FCC Warning	8

Specifications

General Info	
Net weight	Approximately 9.5 kg (21 lbs)
Dimensions	400 × 211 × 281 mm (15.7 × 8.3 × 11.1 in.)
Capacity	1,024Wh 51.2V ≐
Input Port	
Extra Battery Port Input	51.2V ≐ 1,024W Max (X-Stream and solar dual charging)
Output Port	
Extra Battery Port Output	51.2V ≐ 2,048W Max
Battery Info	
Cell Chemistry	LFP
Cycle Life	3,000 cycles to 80% + capacity
Protection	Over Voltage Protection, Overload Protection, Over Temperature Protection, Short Circuit Protection, Low Temperature Protection, Low Voltage Protection, Overcurrent Protection
Environmental Operating Temperatures	
Optimal Operating Temperature	20°C - 30°C (68°F - 86°F)
Discharging Temperature	-10°C - 45°C (14°F - 113°F)
Charging Temperature	0°C - 45°C (32°F - 113°F)
Storage Temperature	-10°C - 45°C (14°F - 113°F)(Optimal: 20°C - 30°C (68°F - 86°F))



Whether the product can be charged or discharged depends on the actual temperature of the battery pack.



Safety Instructions

Usage

1. Do not use the product near a heat source, such as a fire source or a heating furnace.
2. Avoid contact with any liquid. Do not immerse the product in water or get it wet. Do not use the product in rain or humid environments.
3. Do not use the product in an environment with strong static electricity/magnetic fields.
4. Do not disassemble the product in any way or pierce the product with sharp objects.
5. Avoid using wires or other metal objects that may result in a short circuit.
6. Do not use unofficial components or accessories. If you need to replace any components or accessories, please visit official EcoFlow channels to check relevant information.
7. When using the product, please strictly follow the operating temperature specified in this user manual. If the temperature is too high, it may result in a fire or explosion; if the temperature is too low, the product performance may be severely reduced, or the product may cease to work.
8. Do not stack any heavy objects on the product.
9. Do not forcibly lock the fan during use or place the product in an unventilated or dusty area.
10. Please avoid impact, falls, or severe vibrations when using the product. In case of a severe external impact, turn off the power supply immediately and stop using the product. Ensure the product is well fastened during transportation to avoid vibrations and impacts.
11. If you accidentally drop the product into water during use, please place it in a safe open area, and stay away from it until it is completely dry. The dried product should not be used again, and should be properly disposed of according to "Disposal" below. If the product catches fire, we recommend that you use fire extinguishers in the following order: water or water mist, sand, fire blanket, dry powder, and finally a carbon dioxide fire extinguisher.
12. Use a dry cloth to clean off dirt on the product ports.
13. Rest the product on a flat surface to avoid damages caused by the product falling over. If the product is overturned and severely damaged, turn it off immediately, place the battery in an open area, keep it away from combustible matter and people, and dispose of it in accordance with local laws and regulations.
14. Ensure that the product is kept out of reach of children and pets.
15. The Smart Extra Battery cannot be used separately. **DO NOT** connect the Smart Extra Battery to another Smart Extra Battery.

Disposal

1. If conditions permit, make sure that the battery is fully discharged before disposing it in a designated battery recycling bin. The product contains batteries with potentially dangerous chemicals, so it is strictly prohibited to dispose of it in ordinary trash cans. For more details, please follow the local laws and regulations on battery recycling and disposal.
2. If the battery cannot be fully discharged due to a product failure, please do not dispose of the

battery directly in the battery recycling box. In such a case, you should contact a professional battery recycling company for further processing.

3. Please dispose of over-discharged batteries that cannot be recharged.

What's in the Box

DELTA 2
Smart Extra Battery



DELTA 2
Extra Battery Cable

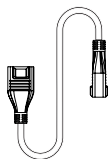

User Manual & Warranty
Card

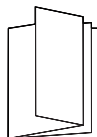

Product Details

Overview

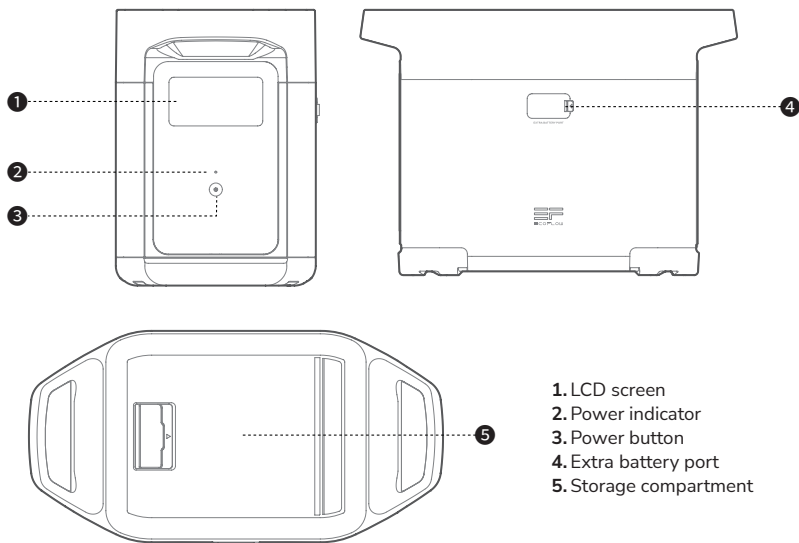

LCD Screen

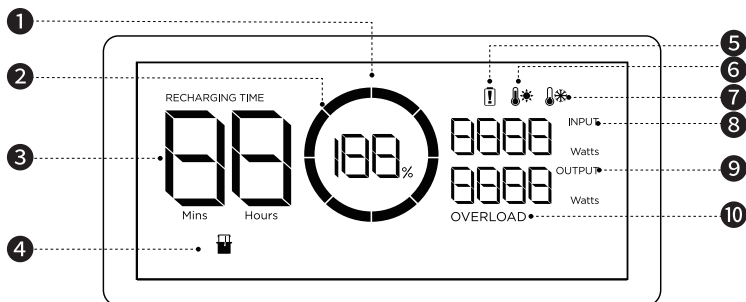

- | | |
|--|-----------------------------|
| 1. Remaining battery percentage | 6. High temperature warning |
| 2. Battery level indicator | 7. Low temperature warning |
| 3. Remaining charging/discharging time | 8. Input power |
| 4. Extra Battery indicator | 9. Output power |
| 5. Battery failure warning | 10. Overload warning |

Icon	Name	Status
	Remaining battery percentage	Charging: rotates clockwise Fully charged: displays 100% 0% battery: icon flashes



Check "Troubleshooting" for details.

Power On/Off

Press the power button to turn on the product. The LCD screen lights up with the battery level indicator figure displayed. Press and hold the power button to turn off the product.

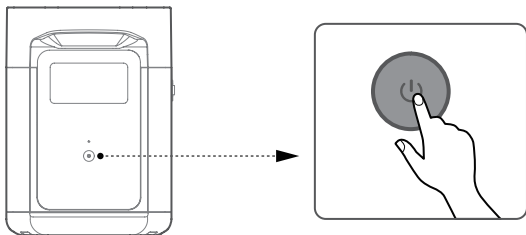

1. The Extra Battery is meant to be used with DELTA 2, it cannot be used separately.
2. If the product is not used for 5 minutes, it will enter sleep mode with the LCD screen shut off. When you start to use the product again, the LCD screen will turn on automatically.
3. The product defaults to 2 hours of standby time. With the output power buttons turned off and no other load for 2 hours, the product will shut off automatically. You can set the standby duration in the app.

Usage

With DELTA 2

The DELTA 2 can be connected to one Extra Battery to meet more extensive requirements.

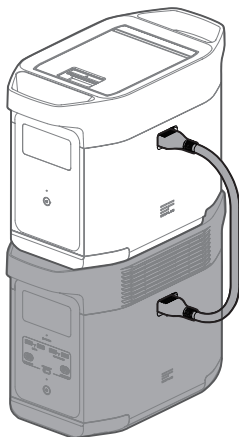



1. Make sure both DELTA 2 and the Extra Battery are turned off before connecting.
2. The Extra Battery icons will show up on LCD screens after you connect the product to the DELTA 2; afterwards, you can start charging or discharging.
3. Do not connect the DELTA 2 to the battery during charging/discharging process.
4. Do not touch the metal pins of the ports with your hands or other objects. Gently wipe the product clean with a clean and dry cloth when necessary.

With a Smart Generator

You may recharge the product with a Smart Generator, please refer to the Smart Generator User Manual for details.

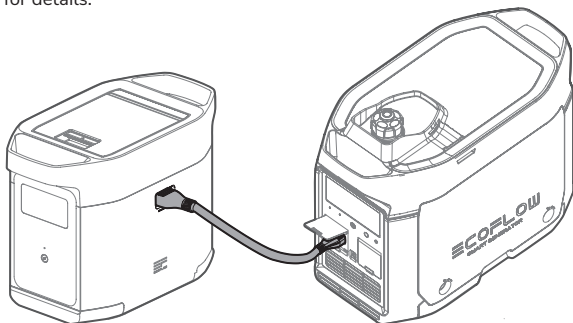

Storage and Maintenance

1. Keep the product away from water, heat sources, or metal objects.
2. Store the product in the places of 20°C to 30°C (°F to °F) to extend its battery life.
3. For long-term storage, please discharge the product every three months (firstly discharge it to 0%, then fully recharge it, and lastly discharge it to 60%); the product will not be covered by the warranty if it is not charged or discharged for more than 6 months.
4. For safety, do not use or store the product in places of below -10°C or above 45°C for a long time.
5. If the product is left unused for a long time, it'll enter sleep mode. Please charge the product before you need to use it again.

FAQ

1. What battery does the product use?

It uses a high-quality LFP battery.

2. How do I know if the product is charging?

When it's charging, the remaining charging time will be shown on the LCD Screen. Meanwhile, the charging indicator icon begins to rotate with the remaining battery percentage and the input power shown on the right of the circle.

3. How do I clean the product?

Please gently wipe it with a dry, soft, clean cloth or paper towel.









4. How do I store the product?

Before storing, please turn off the product first, and then store it in a dry, ventilated place at room temperature. Do not place it near water sources. For long-term storage, please discharge and recharge the product every three months to extend its battery life.

5. Can I take the product on a plane?

No.

Troubleshooting

Indicator	Problem	Solution
RECHARGING TIME   Flashing	High temperature charging protection	Charging will resume automatically once the battery cools down.
  Flashing	High temperature discharging protection	Charging will resume automatically once the battery cools down.
RECHARGING TIME   Flashing	Low temperature charging protection	Charging will resume automatically once the battery temperature rises above 5°C (41°F)
  Flashing	Low temperature discharging protection	The power supply will resume automatically once the battery temperature rises above -12°C (10°F).
Overload Flashing	Battery discharging overload/short circuit protection	Remove overloaded appliances
 Solid	Battery failure	Contact the after-sales service



If a warning sign shows on the LCD screen during use and does not disappear after a restart, please stop using it immediately (do not try to charge or discharge). If you require more assistance, please contact EcoFlow customer service.

FCC Warning

This device complies with part 15 of the FCC Rules. Operation is subject to the following two conditions: (1) This device may not cause harmful interference, and (2) this device must accept any interference received, including interference that may cause undesired operation.

Any Changes or modifications not expressly approved by the party responsible for compliance could void the user's authority to operate the equipment.

Note: This equipment has been tested and found to comply with the limits for a Class B digital device, pursuant to part 15 of the FCC Rules. These limits are designed to provide reasonable protection against harmful interference in a residential installation. This equipment generates uses and can radiate radio frequency energy and, if not installed and used in accordance with the instructions, may cause harmful interference to radio communications. However, there is no guarantee that interference will not occur in a particular installation. If this equipment does cause harmful interference to radio or television reception, which can be determined by turning the equipment off and on, the user is encouraged to try to correct the interference by one or more of the following measures:

- Reorient or relocate the receiving antenna.
- Increase the separation between the equipment and receiver.
- Connect the equipment into an outlet on a circuit different from that to which the receiver is connected.
- Consult the dealer or an experienced radio/TV technician for help.

This equipment complies with FCC radiation exposure limits set forth for an uncontrolled environment.

This equipment should be installed and operated with minimum distance 20cm between the radiator & your body.

≡COFLOW